

Configurations

CONFIGURATIONS	PART SELECTIONS	PART NUMBER	DESCRIPTIONS	REF. PAGE
#60210 series C-clamp mount Adjustable LCD arm   	1. Pivot head	#21-01	VESA 75 pivot head	7
		#21-01H	Heavy duty pivot head(VESA 75)	7
		#21-21Q	VESA 75 quick release pivot head	7
		2. Adjustable arm	#22-01-2	Arm reach 310mm(12") for (3kgs - 8kgs)
	#22-04-2		Arm reach 380mm(15") for (1.5kgs - 6kgs)	8
	#22-04-3		Arm reach 380mm(15") for (3kgs - 8kgs)	8
	#22-04-5		Arm reach 380mm(15") for (7.5kgs - 13kgs)	8
	#22-02-3		Arm reach 430mm(17") for (3kgs - 5.5kgs)	8
	#22-02-4		Arm reach 430mm(17") for (4.5kgs - 8kgs)	8
	#22-02-5		Arm reach 430mm(17") for (7kgs - 11kgs)	8
	#22-09-5		Slim adjustable arm 420mm for (1kg -5kgs)	8
	#22-09-8	Slim adjustable arm 420mm for (4kgs - 8kgs)	8	
	3. Extension arm	#22-06-1	Die casting swing arm 165mm(6.5")	7
		#22-07-2	Double LCD mount extended bar	7
	4. Mount	#25-01J	C-Clamp	9
	#60212 series Vertical surface mount Adjustable LCD arm   	1. Pivot head	#21-01	VESA 75 pivot head
#21-01H			Heavy duty pivot head(VESA 75)	7
#21-21Q			VESA 75 quick release pivot head	7
2. Adjustable arm		#22-01-2	Arm reach 310mm(12") for (3kgs - 8kgs)	8
		#22-04-2	Arm reach 380mm(15") for (1.5kgs - 6kgs)	8
		#22-04-3	Arm reach 380mm(15") for (3kgs - 8kgs)	8
		#22-04-5	Arm reach 380mm(15") for (7.5kgs - 13kgs)	8
		#22-02-3	Arm reach 430mm(17") for (3kgs - 5.5kgs)	8
		#22-02-4	Arm reach 430mm(17") for (4.5kgs - 8kgs)	8
		#22-02-5	Arm reach 430mm(17") for (7kgs - 11kgs)	8
		#22-09-5	Slim adjustable arm 420mm for (1kg -5kgs)	8
#22-09-8		Slim adjustable arm 420mm for (4kgs - 8kgs)	8	
3. Extension arm		#22-06-1	Die casting swing arm 165mm(6.5")	7
		#22-07-2	Double LCD mount extended bar	7
4. Mount		#25-12	Two ear wall mount bracket	9
		#25-15	Die casting wall mount bracket	9
	#25 pole clamp	Pole clamps for various pole sizes	9	
	#25-50	Track mount bracket (For P25-50-13 track only)	9	
#60216 Series Compact LCD arm  	1. Pivot head	#21-01	VESA 75 pivot head	7
		#21-01H	Heavy duty pivot head(VESA 75)	7
	2. Mount	#21-21Q	VESA 75 quick release pivot head	7
		#25-12	Two ear wall mount bracket	9
		#25-15	Die casting wall mount bracket	9
		#25 pole clamp	Pole clamps for various pole sizes	9
		#25-50	Track mount bracket (Excluding P25-50-13 track)	9







Configurations

CONFIGURATIONS	PART SELECTIONS	PART NUMBER	DESCRIPTIONS	REF. PAGE
#60217 Series LCD desk top pedestal 		#21-01	VESA 75 pivot head	7
	1. Pivot head	#21-01H	Heavy duty pivot head(VESA 75)	7
		#21-21Q	VESA 75 quick release pivot head	7
	2. Pole	#23-12	Dia. 1-1/4" x L 8" short pole	7
		#23-13	Telescopic pole, height adjustment from 315mm to 415mm	7
	3. Extension arm	#22-06-1	Die casting swing arm 165mm(6.5") (Option)	7
	4. Mount	#25-02J	C-clmap for dia. 1-1/4" pole	10
		#25-24	Die casting grommet for dia. 1-1/4" pole	10
#60217F Series LCD Free stand 		#21-01	VESA 75 pivot head	7
	1. Pivot head	#21-01H	Heavy duty pivot head(VESA 75)	7
		#21-21Q	VESA 75 quick release pivot head	7
	2. Pole	#23-12	Dia. 1-1/4" x L 8" short pole	7
		#23-13	Telescopic pole, height adjustment from 315mm(12 3/8") to 415mm(16 3/8")	7
	3. Base	#25-36	Free base for for dia. 1-1/4" pole	10
#60218 Series Extended Holder  	1. Keyboard tray	#24-07A	Keyboard clamp	9
	2. Mouse tray	P24-12-10A	Extended mouse tray	9
	3. Pivot head	#21-14	Fold up tray pivot unit	7
		#22-03-3	Short extension arm 250mm(9 7/8")	7
		#22-03-4	Long extension arm 450mm(17 11/16")	7
	4. Extension arm	#22-06-1	Die casting swing arm 165mm(6.5") for pole clamp only	7
		#25-12	Two ear wall mount bracket	9
	5. Mount	#25-15	Die casting wall mount bracket	9
		#25 pole clamp	Pole clamps for various pole sizes	9
		#25-50	Track mount bracket (For P25-50-13 track only)	9
#60219 Series Vertical surface mount Keyboard holder  	1. Keyboard tray	#24-07A	Keyboard clamp	9
	2. Mouse tray	P24-12-10A	Extended mouse tray	9
	3. Pivot head	#21-14	Fold up tray pivot unit	7
		#22-04-3	Arm reach 380mm(15") for (3kgs - 8kgs)	8
		#22-02-3	Arm reach 430mm(17") for (3kgs - 5.5kgs)	8
	4. Adjustable arm	#22-09-5	Slim adjustable arm 420mm for (1kg -5kgs)	8
		#25-12	Two ear wall mount bracket	9
		#25-15	Die casting wall mount bracket	9
	5. Mount	#25 pole clamp	Pole clamps for various pole sizes	9
#25-50		Track mount bracket (For P25-50-13 track only)	9	





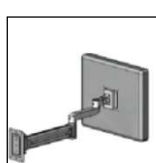

Configurations

CONFIGURATIONS	PART SELECTIONS	PART NUMBER	DESCRIPTIONS	REF. PAGE
#60220 series		#21-01	VESA 75 pivot head	7
Desk top mount	1. Pivot head	#21-01H	Heavy duty pivot head(VESA 75)	7
Adjustable LCD arm		#21-21Q	VESA 75 quick release pivot head	7
	2. Adjustable arm	#22-01-2	Arm reach 310mm(12") for (3kgs - 8kgs)	8
		#22-04-2	Arm reach 380mm(15") for (1.5kgs - 6kgs)	8
		#22-04-3	Arm reach 380mm(15") for (3kgs - 8kgs)	8
		#22-04-5	Arm reach 380mm(15") for (7.5kgs - 13kgs)	8
		#22-02-3	Arm reach 430mm(17") for (3kgs - 6kgs)	8
		#22-02-4	Arm reach 430mm(17") for (4.5kgs - 8kgs)	8
		#22-02-5	Arm reach 430mm(17") for (7kgs - 11kgs)	8
		#22-09-5	Slim adjustable arm 420mm for (1kg -5kgs)	8
	#22-09-8	Slim adjustable arm 420mm for (4kgs - 8kgs)	8	
	3. Extension arm	#22-06-1	Die casting swing arm 165mm(6.5")	7
	#22-07-2	Double LCD mount extended bar	7	
4. Mount	#25-22	Steel grommet	9	
	#25-25	Die casting grommet for adjustable arm	9	
#60221 series		#21-01	VESA 75 pivot head	7
Vertical surface mount	1. Pivot head	#21-01H	Heavy duty pivot head(VESA 75)	7
Swing arm		#21-21Q	VESA 75 quick release pivot head	7
	2. Extension arm	#22-03-3	Short extension arm 250mm(9 7/8")	7
		#22-03-4	Long extension arm 450mm(17 11/16")	7
		#22-06-1	Die casting swing arm 165mm(6.5") for pole clamp only	7
		#22-08-1	Single-section dental arm for dental pole clamp only	7
	3. Mount	#25-12	Two ear wall mount bracket	9
		#25-15	Die casting wall mount bracket	9
		#25 pole clamp	Pole clamps for various pole sizes	9
		#25-50	Track mount bracket (Excluding P25-50-13 track)	9
#60222 series		#21-01	VESA 75mm pivot head	7
Vertical surface mount		#21-01Q	Track mount quick release pivot adapter	7
2-arm system	2. Adjustable arm	#22-09-5	Slim adjustable arm 420mm for (1kgs -5kgs)	8
	3. Extension arm	#22-03-3	Short extension arm 250mm(9 7/8")	7
		#22-03-4	Long extension arm 450mm(17 11/16")	7
	4. Mount	#25-12	Two ear wall mount bracket	9
		#25-15	Die casting wall mount bracket	9
		#25 pole clamp	Pole clamps for various pole sizes	9
		#25-50	Track mount bracket (Excluding P25-50-13 track)	9

Configurations

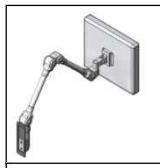
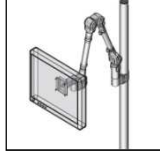
CONFIGURATIONS	PART SELECTIONS	PART NUMBER	DESCRIPTIONS	REF. PAGE	
#60223 series Slim adjustable Laptop holder  	1. Tray	#24-06	Adjustable laptop holder	9	
		#24-21	Laptop platform W380mm x D305mm(15"x12")	9	
	2. Pivot head	#21-01H	Heavy duty pivot head(VESA 75)	7	
		#21-14	Fold up tray pivot unit	7	
	3. Adjustable arm	#22-09-5	Slim adjustable arm 420mm for (1kg -5kgs)	8	
		#25-01J	Two ear wall mount bracket	9	
		#25-15	Die casting wall mount bracket	9	
		#25-22	1.5" compact pole clamp	9	
		#25-25	Die casting grommet for adjustable arm	9	
	4. Mount	#25-XXL	25-44L or 25-45L pole clamps (only)	9	
#25-50		Track mount bracket (Excluding P25-50-13 track)	9		
#60223 series Adjustable NB holder   		1. Tray	#24-06	Adjustable laptop holder	9
			#24-21	Laptop platform W380mm x D305mm(15"x12")	9
	2. Pivot head	#21-01H	Heavy duty pivot head(VESA 75)	7	
		#21-14	Fold up tray pivot unit	7	
	3. Adjustable arm	#22-04-2	Arm reach 380mm(15") for (1.5kgs - 6kgs)	8	
		#22-04-3	Arm reach 380mm(15") for (3kgs - 8kgs)	8	
		#22-02-3	Arm reach 430mm(17") for (3kgs - 5.5kgs)	8	
	4. Mount	#25-01J	Two ear wall mount bracket	9	
		#25-12	Two ear wall mount bracket	9	
		#25-15	Die casting wall mount bracket	9	
#25-22		1.5" compact pole clamp	9		
#25-25		Die casting grommet for adjustable arm	9		
#25-XX		Pole clamps for various pole sizes	9		
#25-50	Track mount bracket (Excluding P25-50-13 track)	9			
#60225 series Vertical surface mount Dual swing arm  	1. Pivot head	#21-01	VESA 75 pivot head	7	
		#21-01H	Heavy duty pivot head(VESA 75)	7	
		#21-21Q	Track mount quick release pivot adapter	7	
	2. Fore arm	#22-03-3	Short extension arm 250mm(9 7/8")	7	
		#22-03-4	Long extension arm 450mm(17 11/16")	7	
		#22-06-1	Die casting swing arm 165mm (for pole mount only)	7	
	3. Back arm	#22-03-3	Short extension arm 250mm(9 7/8")	7	
		#22-03-4	Long extension arm 450mm(17 11/16")	7	
		#22-06-1	Die casting swing arm 165mm	7	
	4. Mount	#25-12	Two ear wall mount bracket (Except #22-06-1)	9	
		#25-15	Die casting wall mount bracket	9	
		#25-XX	Pole clamps for various pole sizes	9	
		#25-50	Track mount bracket (Excluding P25-50-13 track)	9	

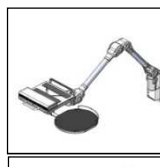

Configurations

CONFIGURATIONS	PART SELECTIONS	PART NUMBER	DESCRIPTIONS	REF. PAGE
#60225 series Pole mount Dual dental arm 	1. Pivot head	#21-01	VESA 75mm pivot head	7
		#21-01H	Heavy duty pivot head(VESA 75)	7
	2. Extension arm	#22-08-2	Single-scetion dental arm/pole mount	7
	3. Pole clamp	#25-44D	Dental arm 1.5" pole clamp	9
		#25-45D	Dental arm 2" pole clamp	9
		#25-54D	Dental arm 40mm pole clamp	9
#25-55D		Dental arm 55mm pole clamp	9	
	#25-56D	Dental arm 60mm pole clamp	9	
#60226 V series Foldable arm  	1. Pivot head	#21-01	VESA 75mm pivot head	7
		#21-01H	Heavy duty pivot head(VESA 75)	7
	2. Foldable arm	#26-21-52	Arm reach 730mm, capacity 3kgs - 9kgs	8
		#26-31-52	Arm reach 830mm, capacity 2kgs - 6kgs	8
	3. Mount	#25-12	Two ear wall mount bracket	9
		#25-15	Die casting wall mount	9
		#25-22	Steel grommet	9
		#25-25	Die casting grommet for adjustable arm	9
		#25-XX	Pole clamps for various pole sizes	9
		#25-50	Track mount bracket (Excluding P25-50-13 track)	9
#60226 Slim series Foldable arm  	1. Pivot head	#21-01	VESA 75mm pivot head	7
		#21-01H	Heavy duty pivot head(VESA 75)	7
	2. Slim foldable arm	#26-85-04	Max. arm reach 850mm, capacity (1kg - 4kgs)	8
		#26-85-07	Max. arm reach 850mm, capacity (4kg - 7kgs)	8
	3. Mount	#25-01J	C-Clamp	9
		#25-15	Die casting wall mount	9
		#25-22	Steel grommet	9
		#25-25	Die casting grommet for adjustable arm	9
		#25-XXL	25-44L or 25-45L pole clamps (only)	9
	#25-50	Track mount bracket (Excluding P25-50-13 track)	9	
#60227 Series LCD Free stand 	1. Pivot head	#21-01	VESA 75mm pivot head	7
		#21-01H	Heavy duty pivot head(VESA 75)	7
		#21-21Q	Track mount quick release pivot adapter	7
	2. Pole	#23-34	1.5" pole 635mm(25") long	7
	3. Pole clamp	#25-44	1.5" compact pole clamp	9
4. Free base	#25-36	1.5" pole free base	10	
#60229 Slim series Foldable arm KB holder  	1. Pivot head	#21-14	Fold up tray pivot unit	7
	3. Slim foldable arm	#26-85-04	Max. arm reach 850mm, capacity (1kg - 4kgs)	8
	4. Keyboard tray	#24-07A	Keyboard clamp	9
	5. Mouse tray	P24-12-10A	Extended mouse tray	9
	6. Mount	#25-15	Die casting wall mount bracket	9
		#25-44L	Extended pole clamps for 1.5" pole	9
	#25-45L	Extended pole clamps for 2" ple	9	

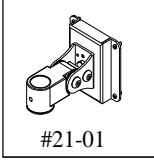
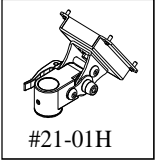
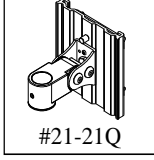
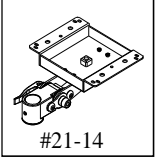
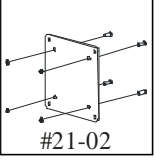

Configurations

CONFIGURATIONS	PART SELECTIONS	PART NUMBER	DESCRIPTIONS	REF. PAGE
#60239 Series Vertical surface mount LCD & KB holder 	1. Pivot head	#21-01	VESA 75mm pivot head	7
	2. LCD/KB pivot	#21-13D	LCD/KB pivot bracket	7
	3. Adjustable arm	#22-04-5	Arm reach 380mm(15") for (7.5kgs - 13kgs)	8
	4. Keyboard tray	#24-07A	Keyboard clamp	9
	5. Mouse tray	P24-12-10A	Extended mouse tray	9
	6. Mount	#25-12 #25-15 #25 Series #25-50	Two ear wall mount bracket 1.5" compact pole clamp Pole clamps for various pole sizes Track mount bracket (Excluding P25-50-13 track)	9 9 9 9
#60240C Series LCD Ceiling mount 	1. VESA mount		VESA 75mm x 75mm(Height adjustable)	
	2. Mount		Swivel ceiling mount	
#60240T Series LCD Grommet mount 	1. Pivot head		VESA 75mm x 75mm(Tilt & Height adjustable)	
	2. Mount		Die casting grommet mount	
#60240F Series Free Stand 	1. Pivot head		VESA 75mm x 75mm(Tilt & Height adjustable)	
	2. Mounting base		Die casting stable free base	
#60272 Series Lift/lock adjustable arm 	1. Pivot head	#21-01H	Heavy duty pivot head(VESA 75)	7
	2. Pivot bracket	#21-15	Vertical pivot set with handle	7
	3. Lockable arm	#22-05-13	Lift & lock adjustable arm (Nominal wieght under 15kgs)	8
	4. Mount	#25-14	Wall mount bracket for #22-05 lift & lock arm	10
		#25-49	2" Pole mount clamp for #22-05 lift & lock arm	10
	#25-35 + #23-42	reinforced round base + pole for #22-05 lift/lock arm	10	
#60279 Series Lift/lock adjustable LCD/KB holder 	1. Pivot head	#21-01H	Heavy duty pivot head(VESA 75)	7
	2. LCD/KB pivot	#21-13D	LCD/KB pivot bracket	7
	3. Pivot bracket	#21-15	Vertical pivot set with handle	7
	4. Lockable arm	#22-05-13	Lift & lock adjustable arm (Nominal wieght under 15kgs)	8
	5. Keyboard tray	#24-07A	Keyboard clamp	9
	6. Mouse tray	P24-12-10A	Extended mouse tray	9
	7. Mount	#25-14 #25-49 #25-35 + #23-42	Wall mount bracket for #22-05 lift & lock arm 2" Pole mount clamp for #22-05 lift & lock arm reinforced round base + pole for #22-05 lift/lock arm	10 10 10

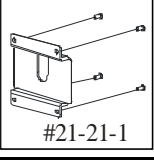
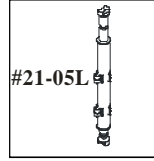
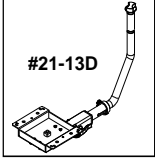
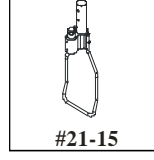
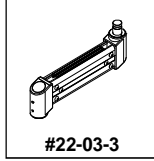
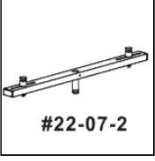
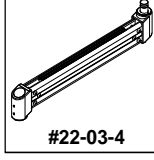
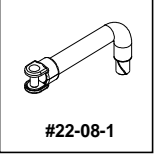
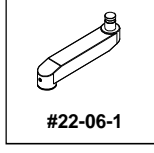
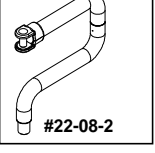

Part information

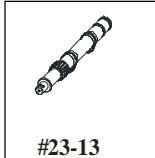
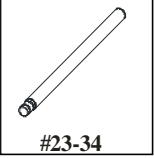
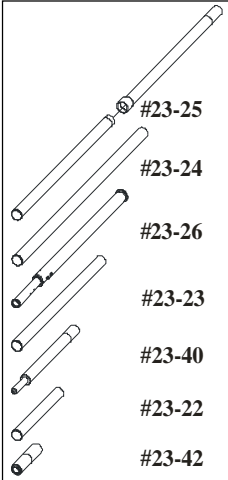
PIVOT HEAD		PART NUMBER	DESCRIPTIONS	ORDER CODE
 <p>#21-01</p>	 <p>#21-01H</p>	#21-01	VESA 75 pivot head (max. load 11kgs)	Non
		#21-01H	VESA 75 heavy duty pivot head (max. load 13kgs)	(H)
 <p>#21-21Q</p>	 <p>#21-14</p>	#21-21Q	VESA 75 quick release pivot head	Non
		#21-14	Fold up tray pivot unit	Non
VESA ADAPTER		PART NUMBER	DESCRIPTIONS	ORDER CODE
 <p>#21-02</p>	 <p>#21-02H</p>	#21-02	VESA 75 to 100 conversion kit	(V)
		#21-02H	VESA 75 to 100 conversion plate with handle	Non
 <p>#21-21-1</p>		#21-21-1	VESA 75 track mount sliding adapter	Non
EXTENDED PIVOT BRACKET		PART NUMBER	DESCRIPTIONS	ORDER CODE
 <p>#21-05L</p>	 <p>#21-13D</p>	#21-05L	Vertical pin (excluding #21-01 pivot head)	Non
		#21-13D	LCD/Keyboard support bracket	Non
 <p>#21-15</p>		#21-15	Vertical pivot set with handle for #22-05 sereis arms	Non
EXTENSION ARM		PART NUMBER	DESCRIPTIONS	ORDER CODE
 <p>#22-03-3</p>	 <p>#22-07-2</p>	#22-03-3	Short extension arm 250mm(9 7/8")	(S)
		#22-03-4	Long extension arm 450mm(17 11/16")	(L)
 <p>#22-03-4</p>	 <p>#22-08-1</p>	#22-06-1	Die casting swing arm 165mm(6 1/2")	(A)
		#22-07-2	Dual LCD mount bar	E
 <p>#22-06-1</p>	 <p>#22-08-2</p>	#22-08-1	Single-section dental arm	(M)
		#22-08-2	Two-section dental arm	(T)

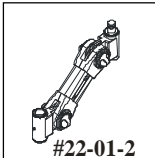
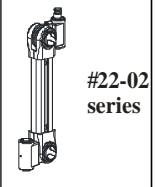
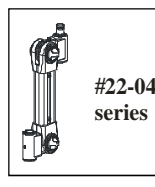
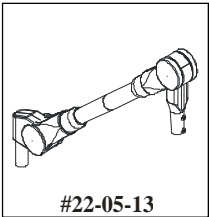

Part information

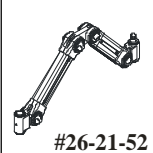
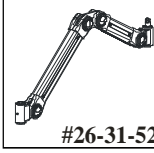
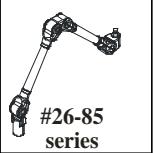
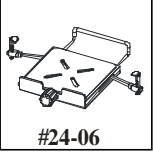
SHORT POLE & TELESCOPIC POLE	PART NUMBER	DESCRIPTIONS	ORDER CODE
  	#23-12	Dia. 1-1/4" x L 8" short pole	(E)
	#23-13	Spring assisted telescopic pole height adjustment from 315mm (12 3/8") to 415mm (16 3/8")	(D)
	#23-34	1.5" pole/635mm (25") long	Non
2" POLE & GAS CYLINDER	PART NUMBER	DESCRIPTIONS	ORDER CODE
	#23-22	Dia. 2" pole x 406mm(16") long	Non
	#23-23	Dia. 2" pole x 813mm(32") long	Non
	#23-24	Dia. 2" pole x 1219mm(48") long	Non
	#23-25	Dia. 2" pole x 1800mm(70") long (2 sections)	Non
	#23-26	2"/1.5" telescopic pole height adjustment from 798mm to 1408mm	Non
	#23-40	Pneumatic lift pole	Non
	#23-42	Desk top mount 2" pole(#22-05 series only)	Non
Adjustable arms	PART NUMBER	DESCRIPTIONS	ORDER CODE
    	#22-01-2	Arm reach 310mm (12") (Loading capacity: 3kgs - 8kgs)	Non
	#22-04-2	Arm reach 380mm (15") (Loading capacity: 1.5kgs - 6kgs)	Non
	#22-04-3	Arm reach 380mm (15") (Loading capacity: 3kgs - 8kgs)	(1)
	#22-04-5	Arm reach 380mm (15") (Loading capacity: 8kgs - 13kgs)	(2)
	#22-02-3	Arm reach 430mm (17") (Loading capacity: 3kgs - 6kgs)	(3)
	#22-02-4	Arm reach 430mm (17") (Loading capacity: 4.5kgs - 8kgs)	(4)
	#22-02-5	Arm reach 430mm (17") (Loading capacity: 7kgs - 11kgs)	(5)
	#22-09-5	Arm reach 424mm (16 3/4") (Loading capacity: 1kgs - 5kgs)	(F)
	#22-09-8	Arm reach 424mm (16 3/4") (Loading capacity: 4kgs - 8kgs)	(E)
#22-05-13	Lift & lock adjustable arm (Nominal wieght under 15kgs)	(G)	

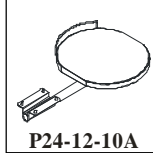
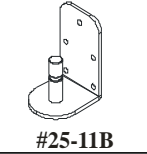
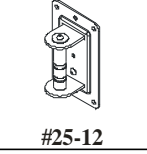
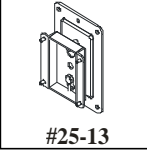
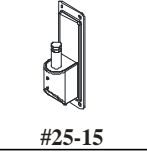
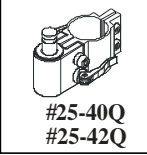
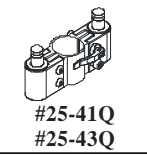
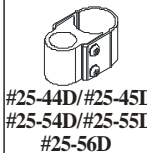
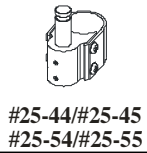
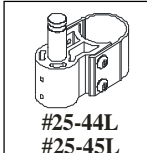
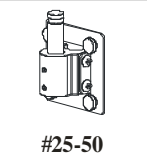
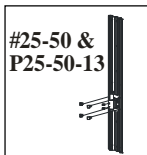
Part information

FODABLE ARM	PART NUMBER	DESCRIPTIONS	ORDER CODE	
 #26-21-52  #26-31-52  #26-85 series	#26-21-52	Max. arm reach 680mm (26 1/2") (Loading capacity: 3kgs to 8kgs)	Non	
	#26-31-52	Max. arm reach 830mm (32 3/4") (Loading capacity: 2kgs to 6kgs)	(V)	
	#26-85-04	Max. arm reach 850mm (33 1/2") (Loading capacity: 1kgs to 4kgs)	(4)	
	#26-85-07	Max. arm reach 850mm (33 1/2") (Loading capacity: 4kgs to 7kgs)	(7)	
NB/KB/TABLET & MOUSE HOLDER	PART NUMBER	DESCRIPTIONS	ORDER CODE	
 #24-06  #24-07A  #24-21  P24-12-10A	#24-06	Adjustable NB/Tablet holder (mouse tray available as options)	(6)	
	#24-07A	Keyboard holder	(7)	
	#24-21	NB platform W380xD305mm (15"x12")	(3)	
	P24-12-10A	Added on extended mouse tray	Non	
VERTICAL SURFACE MOUNTS	PART NUMBER	DESCRIPTIONS	ORDER CODE	
 #25-11B  #25-12  #25-13  #25-15  #25-40Q #25-42Q  #25-41Q #25-43Q  #25-44D/#25-45D #25-54D/#25-55D #25-56D  #25-44/#25-45 #25-54/#25-55  #25-44L #25-45L  #25-50  #25-50 & P25-50-13	#25-11B	L-shaped wall mount (Color in black only)	(L)	
	#25-12	Wall mount bracket	(W)	
	#25-13B	Slim wall mount bracket (Color in black only)	Non	
	#25-15	Die casting wall mount bracket	(D)	
	#25-40Q	Quick release 2" pole clamp	(1)	
	#25-41Q	Quick release 2" dual mount pole clamp	Non	
	#25-42Q	Quick release 1.5" pole clamp	(3)	
	#25-43Q	Quick release 1.5" dual mount pole clamp	Non	
	#25-44	1.5" compact pole clamp	(4)	
	#25-44D	Dental arm 1.5" pole clamp	(4)	
	#25-44L	1.5" extended pole clamp	(4)	
	#25-45	2" compact pole clamp	(5)	
	#25-45D	Dental arm 2" pole clamp	(5)	
	#25-45L	2" extended pole clamp	(5)	
	#25-50	Track mount sliding bracket	Non	
	P25-50-13	Aluminum track(32")	Non	
	#25-54	40mm compact pole clamp	(6)	
	#25-54D	Dental arm 40mm pole clamp	(6)	
	#25-55	55mm compact pole clamp	(7)	
	#25-55D	Dental arm 55mm pole clamp	(7)	
	#25-56D	Dental arm 60mm pole clamp	(8)	

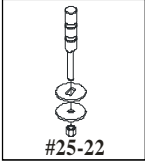
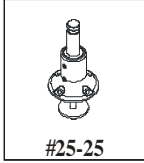
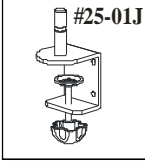
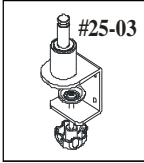
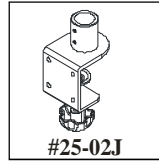
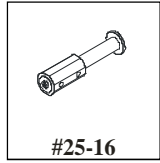
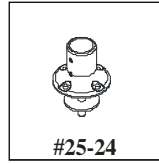
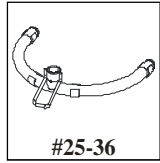
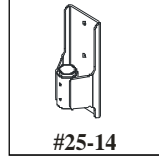
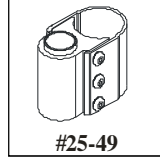
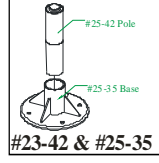
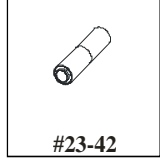
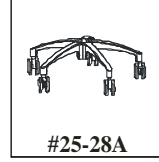
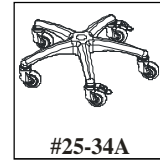
Part information

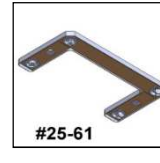
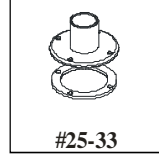
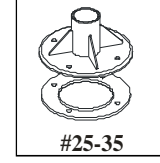
DESK TOP MOUNTS		PART NUMBER	DESCRIPTIONS	ORDER CODE
 <p>#25-22</p>	 <p>#25-25</p>	#25-22	Steel grommet mount	(G)
		#25-25	Die casting grommet mount	(U)
C-CLAMP MOUNTS		PART NUMBER	DESCRIPTIONS	ORDER CODE
 <p>#25-01J</p>	 <p>#25-03</p>	#25-01J	2 in 1 mount C-Clamp	(C)
		#25-03	Heightened C-Clamp	(Q)
PEDESTAL MOUNT FOR 1-1/4" POLE		PART NUMBER	DESCRIPTIONS	ORDER CODE
 <p>#25-02J</p>	 <p>#25-16</p>	#25-02J	1-1/4 pole C-clamp	(P)
		#25-16	Ceiling mount for #28-85 series arms	Non
 <p>#25-24</p>	 <p>#25-36</p>	#25-24	1-1/4 pole die casting base	(T)
		#25-36	1-1/4" pole free base	(F)
#60272 SERIES MOUNTING BRACKETS		PART NUMBER	DESCRIPTIONS	ORDER CODE
 <p>#25-14</p>	 <p>#25-49</p>	#25-14	Wall mount bracket for #22-05 lift & lock arm	(W)
		#25-49	2" Pole mount clamp for #22-05 lift & lock arm	(9)
 <p>#23-42 & #25-35</p>	 <p>#23-42</p>	#25-35	2" pole reinforced round base(Gray)	(H)
		#23-42	2" desk top mount pole for #22-05 lift & lock arm	
2" POLE MOUNTING BASE		PART NUMBER	DESCRIPTIONS	ORDER CODE
 <p>#25-28A</p>	 <p>#25-34A</p>	#25-28A	560mm Aluminium mobile base with 3" wheels	(B)
		#25-34A	2" pole round base	(A)
 <p>#25-39</p>	 <p>#25-61</p>	#25-34A	700mm Aluminium mobile base with 4" wheels	(A)
		#23-35	2" pole reinforced round base	(H)
 <p>#25-33</p>	 <p>#25-35</p>	#25-39	X shaped mobile base(4 x 4" wheels/2 with brake)	(X)

Part information

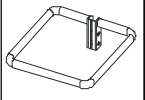
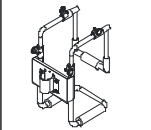
MOBILE CART HANDLE	PART NUMBER	DESCRIPTIONS	ORDER CODE
 <p data-bbox="193 342 295 365">P60250-10</p>	P60250-10	Mobile cart handle (To mount on #25-40Q or #25-42Q 2" pole clamp)	Non
POLE MOUNT CPU HOLDER	PART NUMBER	DESCRIPTIONS	ORDER CODE
 <p data-bbox="228 562 300 584">#60606</p>	#60606	Vertical surface mount adjustable CPU holder (For pole mount or wall mount)	Non

Product number selection guide

Please follow the selection guide step by step for reaching a right model for your usage.

Example: If an slim adjustable arm and an extension arm for wall mount configuration is required for holding a 6kgs LCD with VESA 100mm hole pattern in gray.

1. Wall mount LCD adjustable arm - the selection code is "60212" vertical surface configuration
2. Slim adjustable arm #22-09-8 for holding 6 kgs - the selection code is "E"
3. Die casting swing arm - the selection code is "A"
4. Wall mount bracket #25-15 for slim arm - the selection code is "D"
5. Gray color - the selection code is "G"
6. VESA 100 mm conversion kit #21-02 - the selection code is "V"

The right model shall be #60212-EADGV

6 0 2 1 2

E A D G V



Configurations

- 60210 series - Adjustable LCD arm(C-clamp mount)
- 60212 series - Adjustable LCD arm(vertical surface mount)
- 60215 series - Compact keyboard holder(vertical surface mount)
- 60216 series - Compact LCD bracket(vertical surface mount)
- 60217 series - LCD pedestal stand
- 60218 series - Extended holder(vertical surface mount)
- 60219 series - Adjustable Keyboard holder(vertical surface mount)
- 60220 series - Adjustable LCD arm(desk top mount)
- 60221 series - Single swing LCD arm(vertical surface mount)
- 60222 series - Adjustable 2-arm system(wall mount/pole mount)
- 60223 series - Adjustable holder(wall mount/pole mount)
- 60225 series - Dual swing arm system(wall mount/pole mount)
- 60226 series - LCD foldable arm(desk top/wall/pole mount)
- 60227 series - LCD single mount free stand(desk top/free base)
- 60229 series - Slim foldable adjustable arm keyboard holder
- 60239 series - Adjustable LCD/Keyboard holder
- 60240 series - LCD Free stand/desk top/ceiling mount
- 60250 series - Computer mobile cart
- 60251 series - Pneumatic lift computer mobile cart (27.5" base)
- 60252 series - Pneumatic lift computer mobile cart (22" base)
- 60256 series - Pneumatic lift overbed table
- 60260 series - LCD TV mount bracket(vertical surface mount)
- 60272 series - Lift & lock LCD adjustable arm
- 60279 series - Lift & lock LCD/Keyboard adjustable arm

Color
G - grey
B - black
S - silver

VESA 100

Bracket

- C - #25-01J C-clamp for adjustable arm
- P - #25-02J C-clamp for telescopic pole
- Q - #25-03 heightened C-clamp
- L - #25-11 L-shape wall mount bracket
- W - #25-12 wall mount bracket
- W - #25-14 wall mount bracket for lift/lock arm
- D - #25-15 die casting wall mount bracket
- G - #25-22 steel grommet for adjustable arm
- T - #25-24 1-1/4" die casting base
- U - #25-25 die casting grommet mount
- B - #25-28A 560mm aluminium mobile base
- A - #25-34A 700mm aluminium mobile base
- R - #25-33 round base for 2" pole
- H - #25-35 rein forced round base for 2" pole
- F - #25-36 Free base for 1.5" pole
- X - #25-39 X shaped mobile base
- C - #25-61 C shape low profile mobile base
- 1 - #25-40Q single mount 2" pole clamp
- 3 - #25-42Q single mount 1.5" pole clamp
- 4 - #25-44 series 1.5" compact pole clamp
- 5 - #25-45 series 2" compact pole clamp
- 6 - #25-54 series 40mm pole clamp
- 7 - #25-55 series 55mm pole clamp
- 8 - #25-56 series 60mm pole clamp
- 9 - #25-49 pole clamp for lift/lock adjustable arm

Extension arm or tray

- 0 - none
- 3 - laptop platform #24-21
- 6 - laptop holder #24-06
- 7 - keyboard holder #24-07A
- S - short extension arm #22-03-3
- L - long extension arm #22-03-4
- A - Die casting swing arm #22-06-1

Adjustable arm, extension arm or pedestal

- 0 - none
- 1 - #22-04-3 middle adjustable arm(3kgs - 8kgs)
- 2 - #22-04-5 middle adjustable arm(7.5kgs - 13kgs)
- 3 - #22-02-3 long adjustable arm (3kgs - 6kgs)
- 4 - #22-02-4 long adjustable arm (4.5kgs - 8kgs)
- 5 - #22-02-5 long adjustable arm (7kgs - 11kgs)
- S - #22-03-3 short extension arm length 250mm (9 7/8")
- L - #22-03-4 long extension arm length 450mm (17 11/16")
- 2 - #22-05-13 Lift & lock adjustable LCD arm (15kgs/L23.75") for #60272
- A - #22-06-1 die casting swing arm 165mm (6 1/2")
- M - #22-08-1 single section dental arm
- T - #22-08-2 two section dental arm
- F - #22-09-5 slim adjustable arm 16.5" (Max. 5kgs)
- E - #22-09-8 slim adjustable arm 16.5" (Max. 8kgs)
- E - #23-12 1-1/4" pole 8" long (for 60217 series only)
- D - #23-13 telescopic pole max. height (16 3/8") (for 60217 series only)
- F - #23-34 1.5" pole 25" long (for 60227 series only)
- V - #26-31-52 foldable arm for desk(Max. 6kgs)
- 4 - #26-85-04 slim foldable arm 33.5" long(Max. 4kgs)
- 7 - #26-85-07 slim foldable arm 33.5" long(Max. 7kgs)